

<b>PART No.</b>	SAP-4031	<b>SPECIFICATIONS</b>
<b>PRODUCT</b>	HORN	

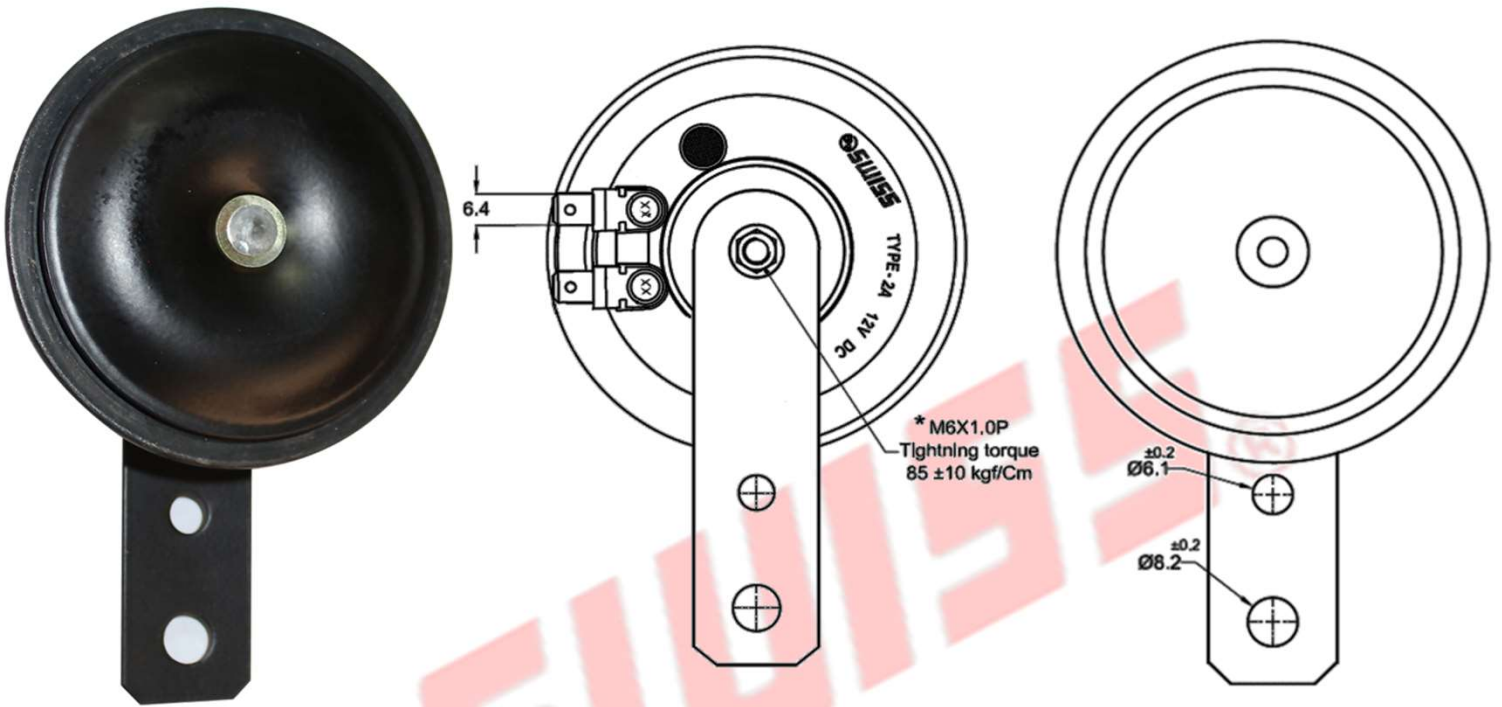

### SPECIFICATIONS

<b>OUTER DIAMETER</b>	75 mm
<b>OPERATING TEMPERATURE</b>	-40 °C ~ +125 °C
<b>WEIGHT</b>	158 gm / 0.348 lbs approx

### **ELECTRICAL DETAILS**

<b>1</b>	<b>OPERATING VOLTAGE RATING</b>	12 V
<b>2</b>	<b>CURRENT RATING</b>	2 AMP
<b>3</b>	<b>FREQUENCY</b>	480 Hz
<b>4</b>	<b>SOUND</b>	110 dB